

	L1	L2
LED 12W	345 mm	390 mm
LED 23W	625 mm	670 mm
LED 33W	905 mm	950 mm
LED 46W	1185 mm	1230 mm
LED 56W	1465 mm	1510 mm
T5 27W / 38W	615 mm	660 mm
T5 45W / 48W	915 mm	960 mm
T5 54W / 62W	1215 mm	1260 mm
T5 85W / 78W	1515 mm	1560 mm

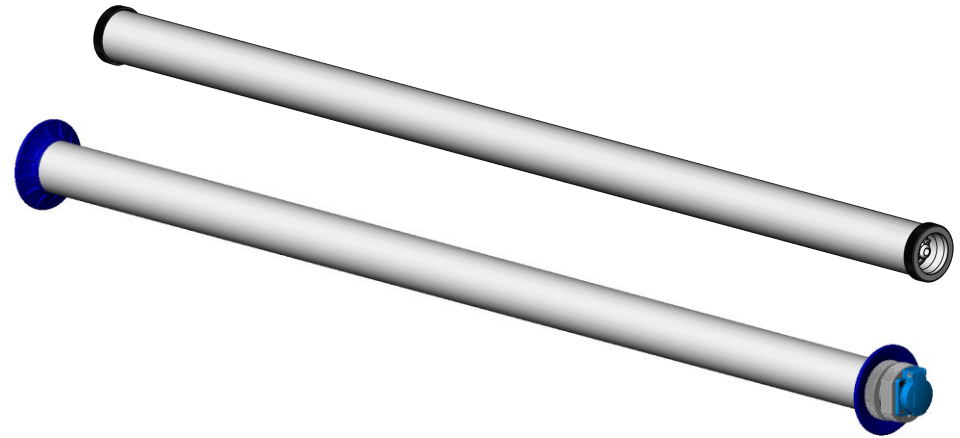

 Spannung voltage	24 V ~ 50-60 Hz 42 V ~ 50-60 Hz 110 V ~ 50-60 Hz 230 V ~ 0/50-60 Hz			
	Schutzart protection class	IP 44	IP 54	IP 67
	Schutzklasse Type of protection	SKL I	SKL II	

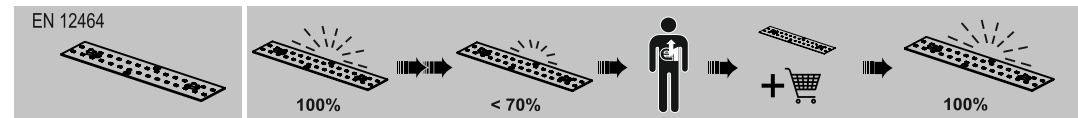
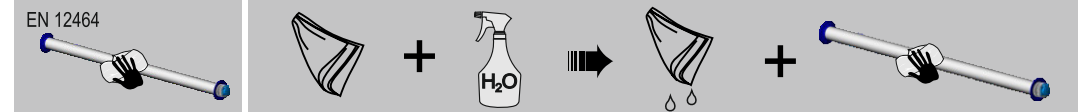

## ÖFFNEN / OPEN

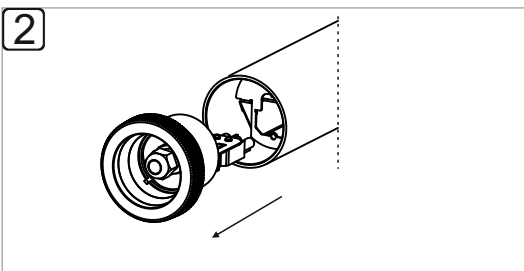
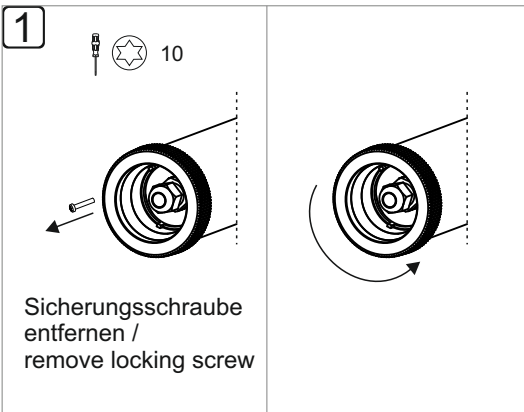

**ÖFFNEN 2. Seite für Durchverdrahtung**  
**OPEN 2nd side for through-wiring**

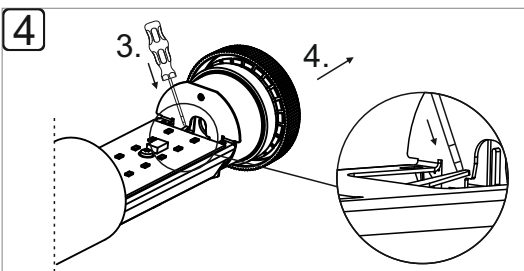
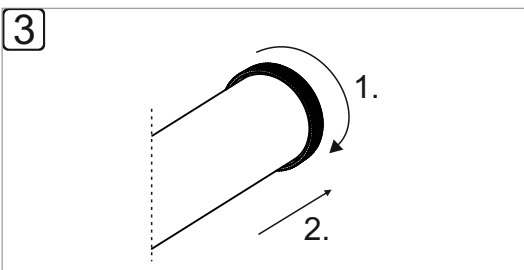

## INSTALLATION / INSTALLATION

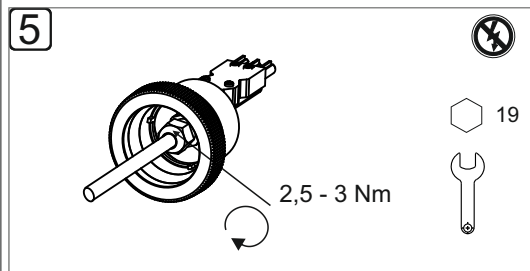
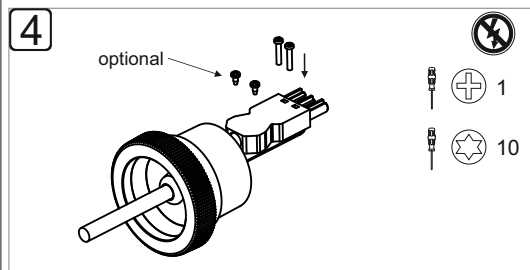
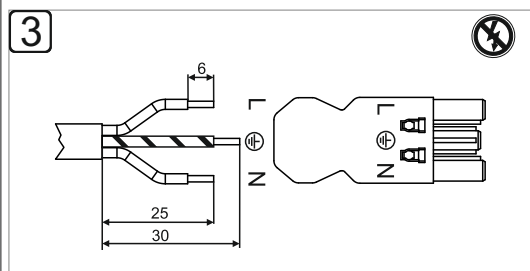
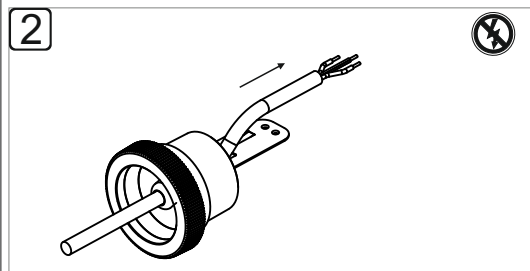
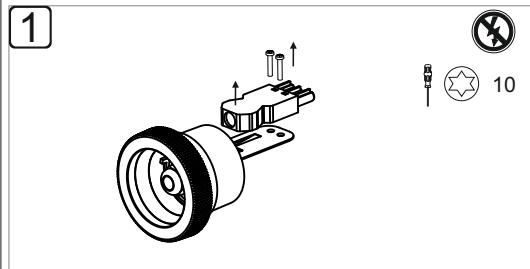

## SCHLIESSEN / CLOSE

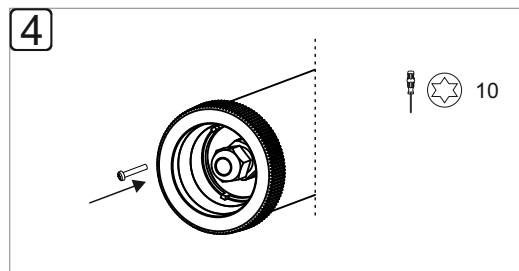
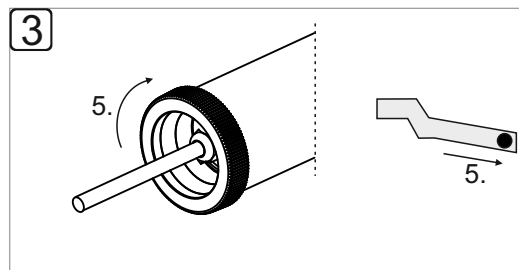
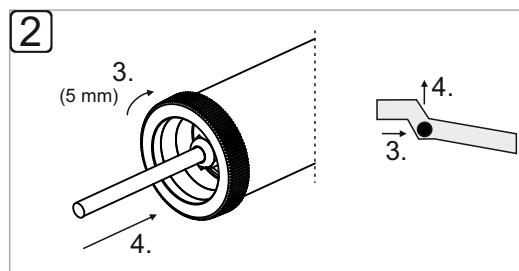
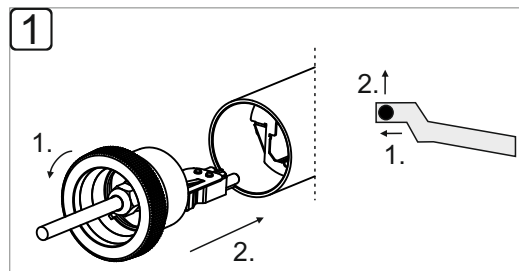
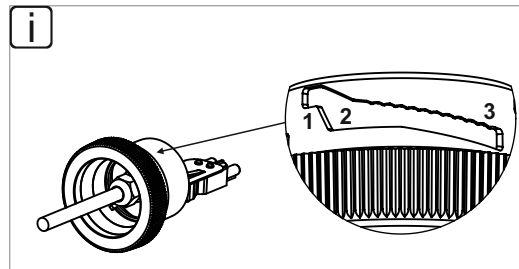

Innenliegender, nicht sichtbarer Ver-  
schlussmechanismus /  
*Inside locking mechanism, not visible*

1. Endkappe bis zum Anschlag drehen /  
*Turn end cap until it stops*  
2. Endkappe vollständig einführen /  
*Fully insert end cap*

3. Endkappe 5mm im Uhrzeigersinn drehen /  
*Turn end cap 5mm clockwise*  
4. Dichtung anpressen / *Press down seal*

5. Endkappe im Uhrzeigersinn fest  
verschließen / *close end cap clockwise  
tightly*

6. Sicherungsschraube eindrehen /  
*screw in safety screw*



#### Allgemeine Sicherheitshinweise

- Der elektrische Anschluss muss ordnungsgemäß nach geltenden Normen und den nationalen sowie internationalen Sicherheits- und Unfallverhütungsvorschriften erfolgen.
- Beschädigte Leuchten dürfen nicht betrieben werden.
- Keine Haftung für Schäden durch unsachgemäßen Einsatz.
- Bei Instandsetzung nur Originalteile verwenden.
- Tragfähigkeit der Decke und Befestigungselemente sicherstellen.

#### Betrieb der Leuchte

- Die unzulässigen Umgebungstemperaturen reduzieren die Lebensdauer der Leuchte, im Extremfall droht der Frühausfall.
- Zur Vermeidung von EMV-Problemen die Durchgangsverdrahtung nicht entlang der Leuchtenverdrahtung führen.
- Steuereingänge von dimmbaren Leuchten mit handelsüblichen für Netzspannung geeigneten Leitungen anschließen

#### Manipulationen unserer Produkte sind unzulässig

Veränderung, Umarbeitung, Umkennzeichnung von Produkten sowie deren Verpackung sind unzulässig und verletzen u.a. unsere eingetragenen Warenzeichenrechte. Solche Modifikationen können technische Eigenschaften unserer Produkte negativ beeinflussen, diese zerstören und möglicherweise Folgeschäden an anderen Objekten verursachen. Für durch derartige Modifikationen verursachte Schäden kann der Hersteller in keinem Fall verantwortlich gemacht werden.



#### General Safety Information

- Electric connection must be appropriate according to all applicable standards and other national and international safety and accident prevention regulations.
- Damaged luminaires must not be operated.
- No liability is accepted for damages resulting from improper use.
- Use genuine parts only for repair.
- Ensure stability of the ceiling and fastening elements.

#### Operation of the luminaire

- Exceeding the permissible ambient temperature will reduce the luminaire's lifecycle, resulting in premature failure in extreme cases.
- Avoid ESD problems by not routing feed-through wiring directly along the wiring of the luminaire.
- Connect control inputs of dimmable luminaires with standard cables suitable for power supply voltage.

#### Manipulation of our products is not permitted

Modifications, reworking, re-labelling of products as well as their package is not permitted and infringes, amongst others, our registered trademark rights. Such modifications may affect technical properties of our products, damage them and possibly cause consequential damage to other objects. The manufacturer shall not be responsible under any circumstances for damage caused by such modifications.



Bei Fragen zu unseren Symbolen, besuchen Sie folgende Webseite:  
 If you have any questions about our signs, visit the following website:

[www.rzb.de/fileadmin/assets/downloads/PDF/RZB\\_Symbolklaerung.pdf](http://www.rzb.de/fileadmin/assets/downloads/PDF/RZB_Symbolklaerung.pdf)

Jede zersprungene Schutzabdeckung ist zu ersetzen. DIN EN 60598  
 Replace any cracked protective shield. IEC 60598

**EEK** Dieses Produkt enthält eine Lichtquelle der Energieeffizienzklasse A++  
 entsprechend Verordnung (EU) 874/2012.  
 This product contains a light source of energy efficiency class A++  
 according to regulation (EU) No 874/2012.

