

INSTRUCTION

Schutzrohrleuchte LED
68A46160-0062.NL



~ 42 V 50/60 Hz IP 44 IK08



2 x 1,5 mm²
 H07RN-F 5 m

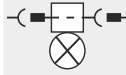

Umgebungstemperatur /
temperature ambiante
=> 5 °C ... + 35 °C

3 x 1 h
 NiMH
6 V - 2,2 Ah

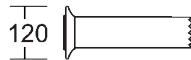
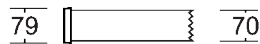
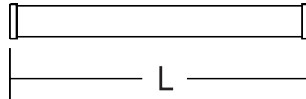
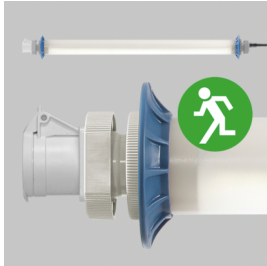

D 120, L 1363



3,4 kg



Φ [lm]

P [W]

Φ [lm]

P

LED

6650

47

480

4 x 10 W

CCT [K]

CRI

RG

EEK

5000

80

RG 0

C

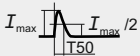

25,3 A / 451 μ s

COS φ

0,95



CEE
42VACx1

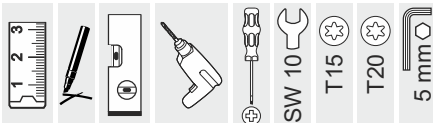



Installation erfordert
Elektro-Fachkraft!
Symbole nach ISO 7010



Allgemeine Sicherheitshinweise

- Der elektrische Anschluss muss ordnungsgemäß nach geltenden Normen und den nationalen sowie internationalen Sicherheits- und Unfallverhütungsvorschriften erfolgen.
- Beschädigte Leuchten dürfen nicht betrieben werden.
- Keine Haftung für Schäden durch unsachgemäßen Einsatz.
- Bei Instandsetzung nur Originalteile verwenden.
- Tragfähigkeit der Decke und Befestigungselemente sicherstellen.

Betrieb der Leuchte

- Die unzulässigen Umgebungstemperaturen reduzieren die Lebensdauer der Leuchte, im Extremfall droht der Frühausfall.
- Zur Vermeidung von EMV-Problemen die Durchgangsverdrahtung nicht entlang der Leuchtenverdrahtung führen.
- Steuereingänge von dimmbaren Leuchten mit handelsüblichen für Netzspannung geeigneten Leitungen anschließen.

Manipulationen unserer Produkte sind unzulässig

Veränderung, Umarbeitung, Umkennzeichnung von Produkten sowie deren Verpackung sind unzulässig und verletzen u.a. unsere eingetragenen Warenzeichenrechte. Solche Modifikationen können technische Eigenschaften unserer Produkte negativ beeinflussen, diese zerstören und möglicherweise Folgeschäden an anderen Objekten verursachen. Für durch derartige Modifikationen verursachte Schäden kann der Hersteller in keinem Fall verantwortlich gemacht werden.



Installation requires
a qualified electrician!
Symbols according
to ISO 7010



General Safety Information

- Electric connection must be appropriate according to all applicable standards and other national and international safety and accident prevention regulations.
- Damaged luminaires must not be operated.
- No liability is accepted for damages resulting from improper use.
- Use genuine parts only for repair.
- Ensure stability of the ceiling and fastening elements.

Operation of the luminaire

- Exceeding the permissible ambient temperature will reduce the luminaire's lifecycle, resulting in premature failure in extreme cases.
- Avoid ESD problems by not routing feed-through wiring directly along the wiring of the luminaire.
- Connect control inputs of dimmable luminaires with standard cables suitable for power supply voltage.

Manipulation of our products is not permitted

Modifications, reworking, re-labelling of products as well as their package is not permitted and infringes, amongst others, our registered trademark rights. Such modifications may affect technical properties of our products, damage them and possibly cause consequential damage to other objects. The manufacturer shall not be responsible under any circumstances for damage caused by such modifications.

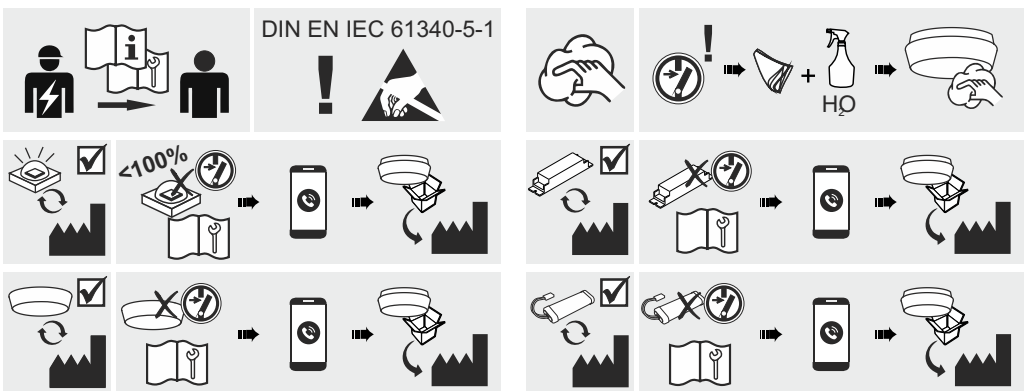

Bei Fragen zu unseren Symbolen, besuchen Sie folgende Webseite:

If you have any questions about our signs, visit the following website:



https://www.rzb.de/fileadmin/assets/downloads/PDF/RZB_Symbolklaerung.pdf

EEK

Dieses Produkt enthält eine Lichtquelle der Energieeffizienzklasse C
entsprechend Verordnung (EU) 2019/2015

This product contains a light source of energy efficiency class C
according to regulation (EU) No 2019/2015



Jede zersprungene Schutzabdeckung ist zu ersetzen. DIN EN 60598



Replace any cracked protective shield. IEC DIN EN 60598

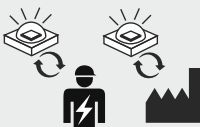

Die Lichtquelle dieser Leuchte darf nur vom Hersteller oder einem
von ihm beauftragten Servicetechniker oder einer vergleichbar
qualifizierten Person ersetzt werden. DIN EN 60598-1 / IEC 60598-1

The light source contained in this luminaire shall only be
replaced by the manufacturer or his service agent or a similar
qualified person. DIN EN 60598-1 / IEC 60598-1



Hinweis zum Einsatz von Leuchten mit D - Kennzeichnung nach EN 60598-2-24
Reference for application of lumiaires with D - marking according to EN 60598-2-24



Umgebung ohne Staubablagerung
Environment without dust deposit



Umgebung mit nicht elektrisch leitender Staubablagerung
Environment with non-electrically conductive dust deposit

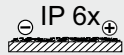

Umgebung mit elektrisch leitender Staubablagerung
Environment with electrically conductive dust deposit

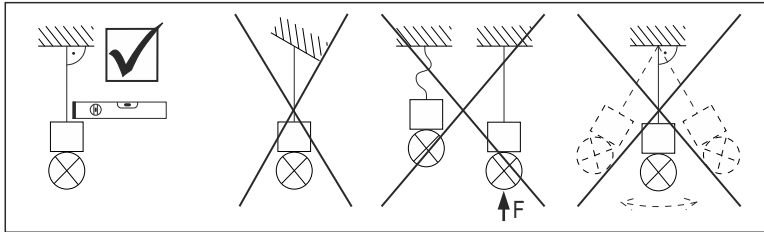
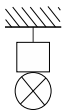



Entsorgung NiMH-Batterie



Richtlinie 2006/66/EG des Europäischen Parlaments und des Rates vom 6. September 2006 über Batterien und Akkumulatoren sowie Altbatterien und -akkumulatoren

Interne Batterie:

- Typ: NiMH-Batterie 6 V 2,2 Ah 5 A
- Energieversorgung beim Notbetrieb - 3 x 1 Stunde
- Nutzungsdauer: < 4 Jahre

Recycling NiMH-battery



Directive 2006/66/EC of the European Parliament and of the Council of 6 September 2006 on batteries and accumulators and waste batteries and accumulators

Internal battery:

- Type: NiMH-battery 6 V 2,2 Ah 5 A
- Power supply during emergency operation - 3 x 1 h
- Service life: < 4 years

Reparaturen, z.B. Austausch einer beschädigten Anschlussleitung, sind ausschließlich vom Hersteller oder Fachbetrieb durchzuführen. /

Repairs, for example replacing a damaged connection cable, must be carried out by the manufacturer or by specialised repair shop. /

Réparations: par exemple d'un câble endommagé doit être effectué par le fabricant ou une société spécialisée.



1

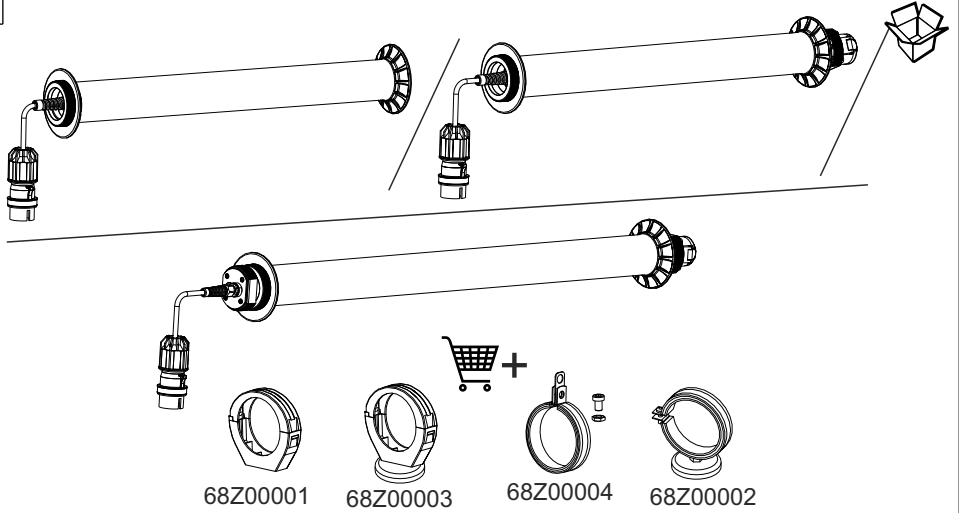

2

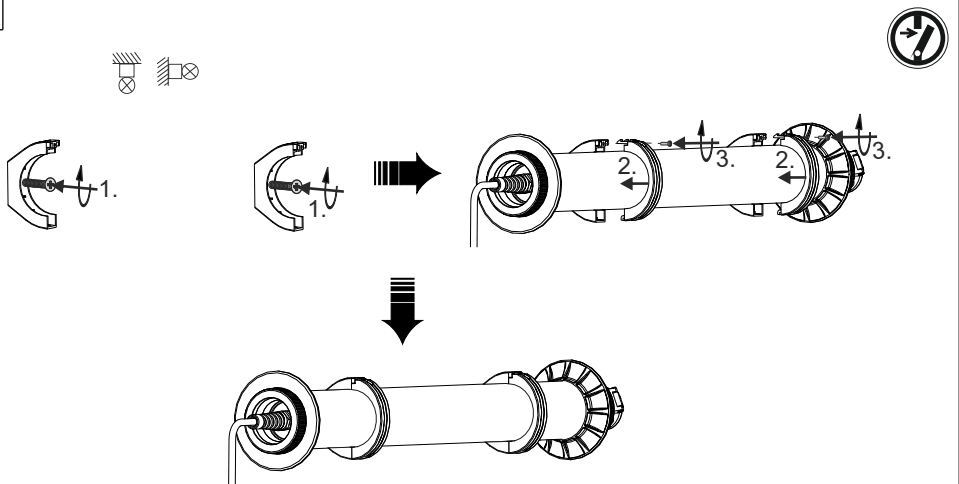

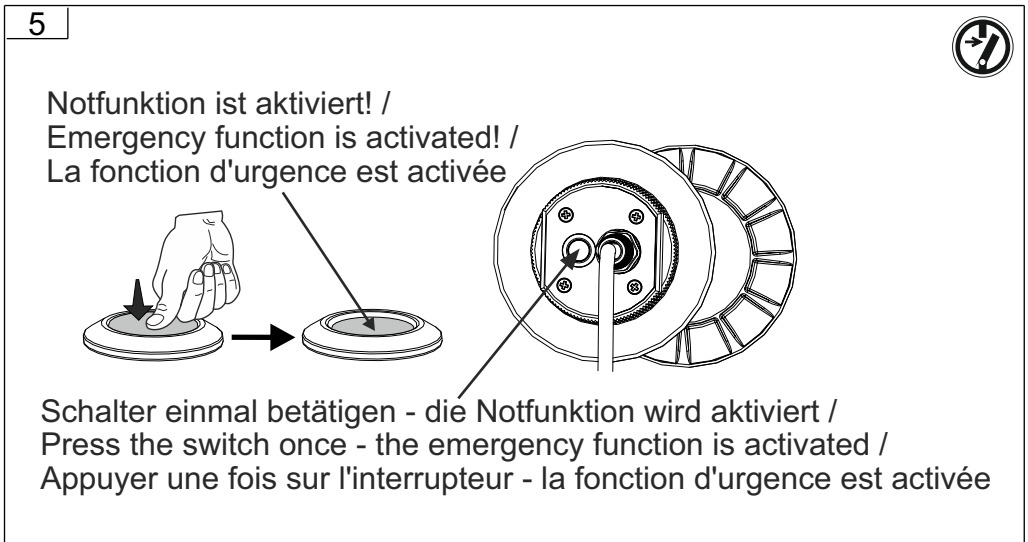
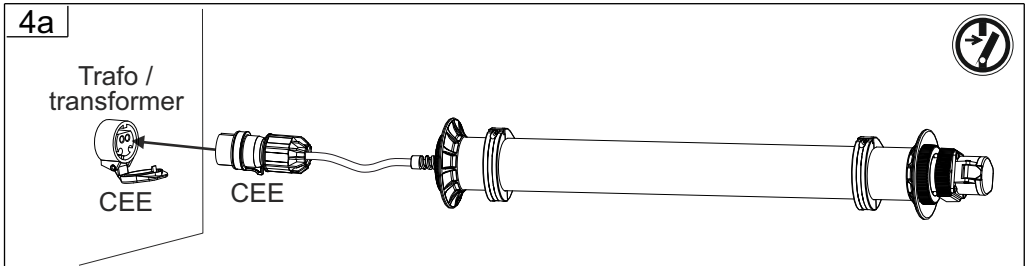
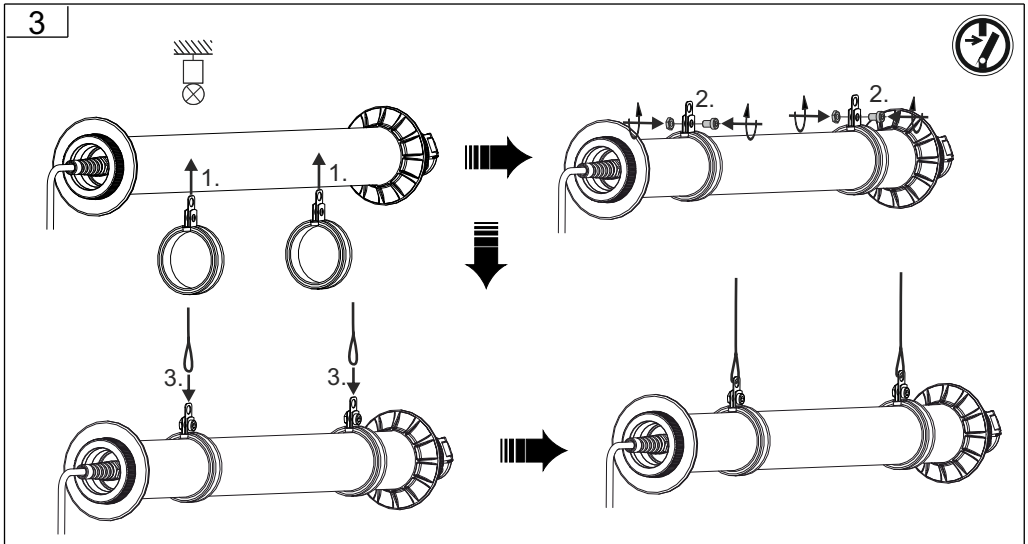

Schalter einmal betätigen - die Notfunktion wird aktiviert /
Press the switch once - the emergency function is activated /
Appuyer une fois sur l'interrupteur - la fonction d'urgence est activée



6a

Trafo /
transformer

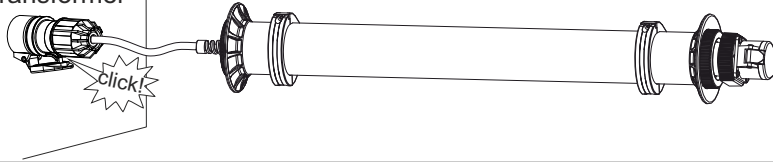

4b

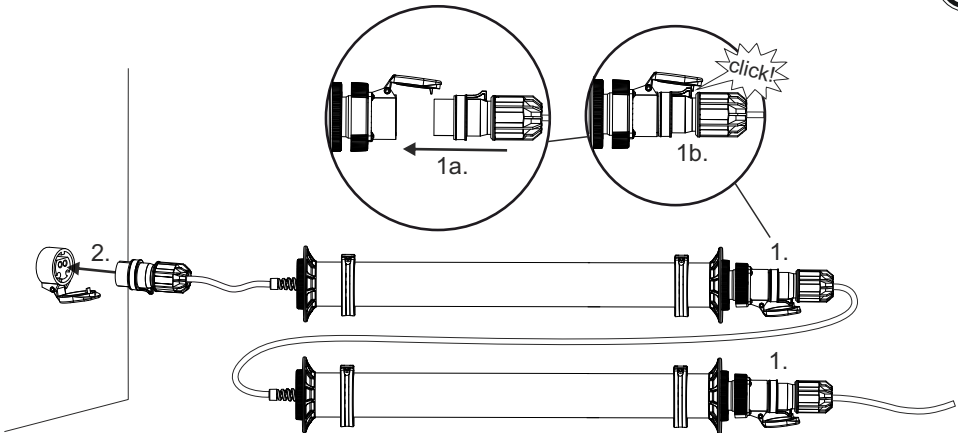

5b

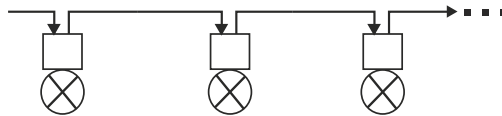
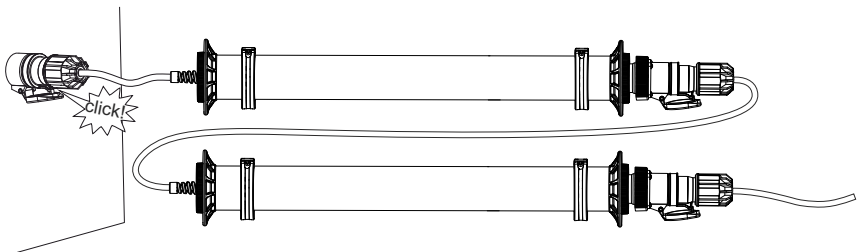

! $I \leq 10 \text{ A}$

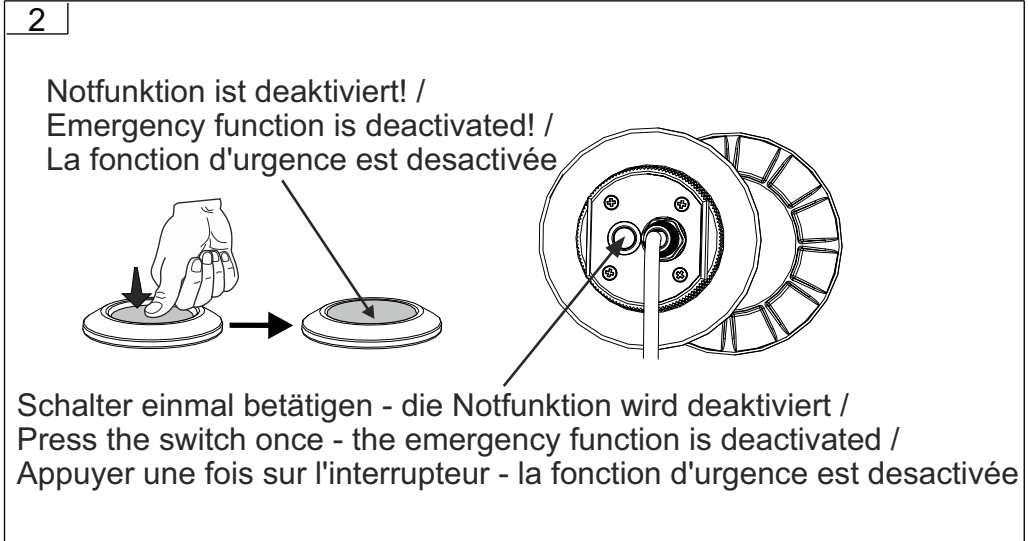
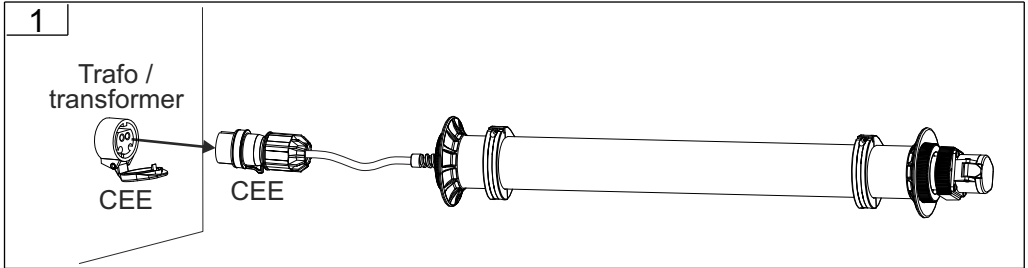

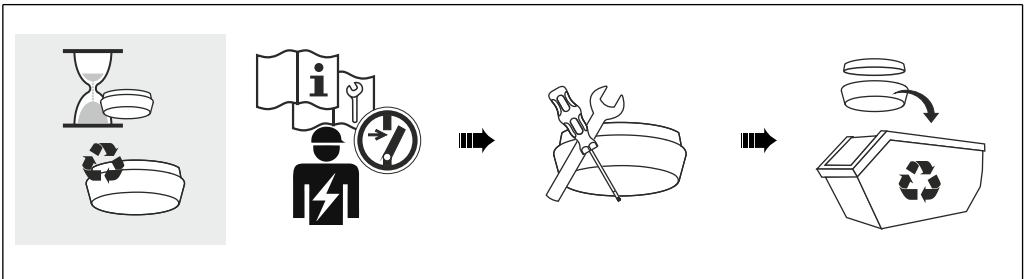
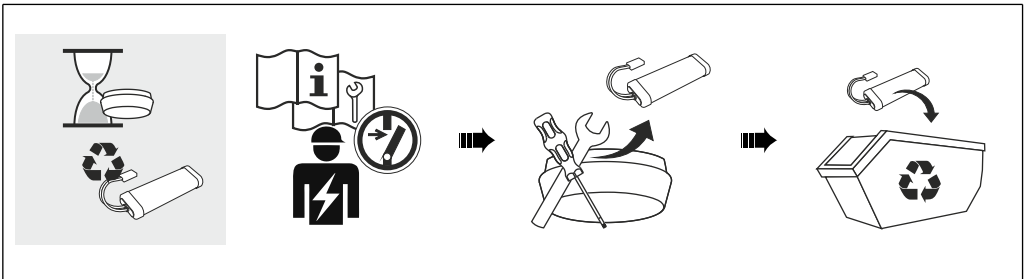
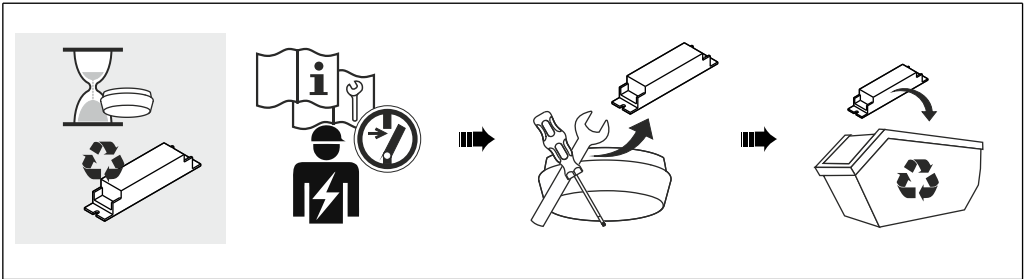
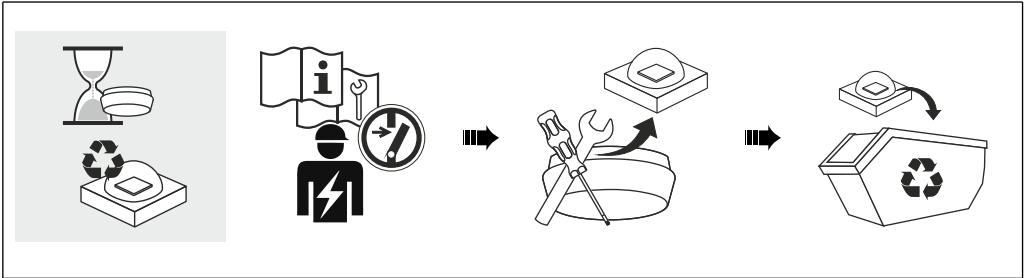



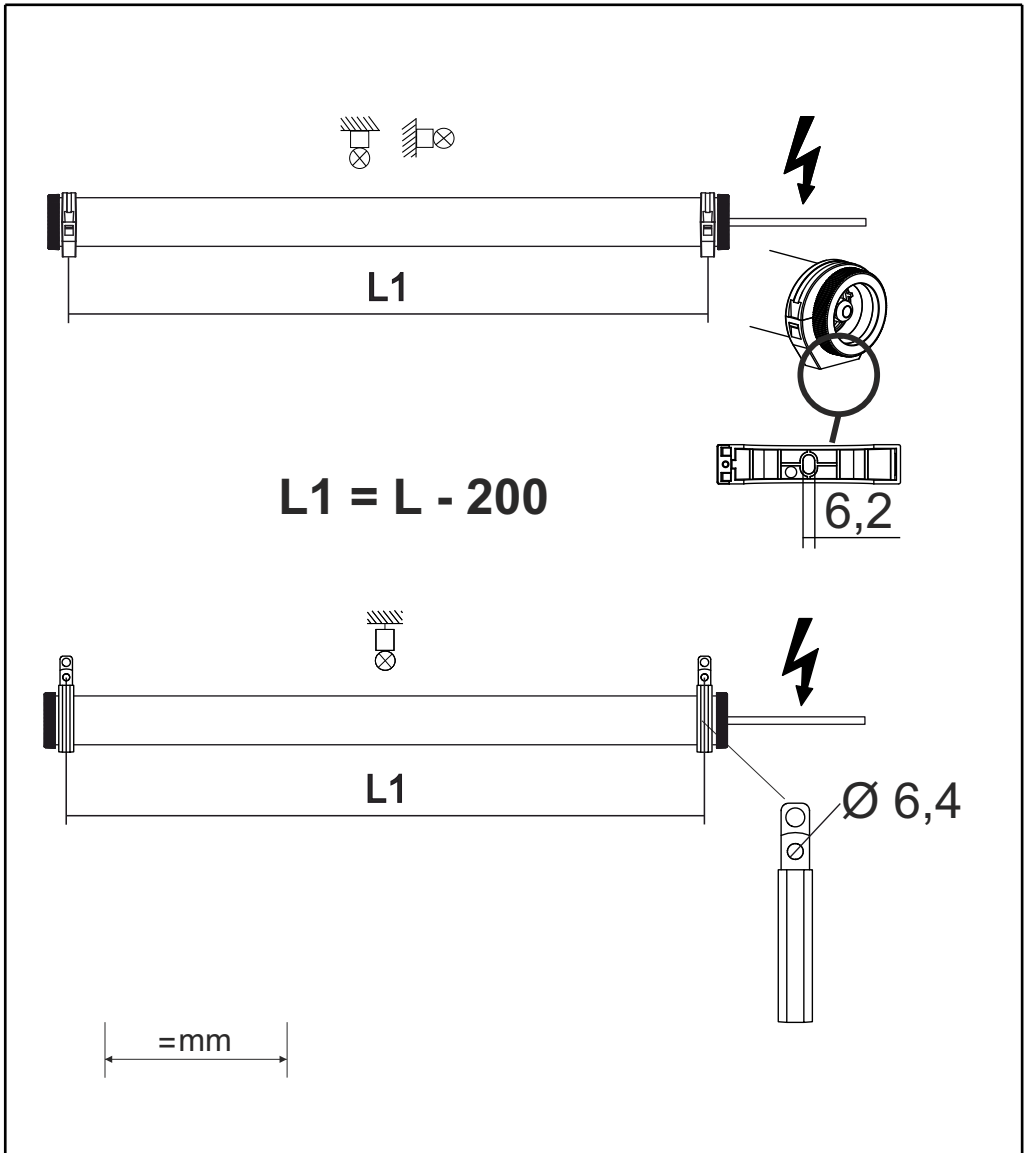

SONLUX Lighting GmbH

🏠 Frankenhäuser Str. 66, 99706 Sondershausen

☎ + 49 3632 6522-0

📠 +49 3632 6522-822

🌐 info@sonlux.de