



 **Made in
GERMANY**

POWERDISK

LARGE AREA LIGHTING

POWERDISK

Mobile large area light



URNS NIGHT INTO DAY – A MOBILE MASTERPIECE

It's the perfect choice whenever you need even and powerful lighting quickly: the POWERDISK made by SONLUX. Equipped with the very latest LED technology including passive cooling, this wide area luminaire is a mobile masterpiece; because it combines maximum light output and mobility with superbly simple handling and outstanding robustness. The POWERDISK provides a remarkable 52,000 lumen of actually available luminous flux to powerfully and safely illuminate building and assembly sites or sports and leisure events, or to aid rescue and emergency operations.

ADDITIONAL ADVANTAGES

- ⊕ Quick one-man installation
- ⊕ Maintenance-free (passive cooling)
- ⊕ Suitable for wind loads up to 150 km/h
- ⊕ Robust, impact-resistant construction
- ⊕ Anti-glare illumination thanks to opal cover
- ⊕ Dimmable
- ⊕ Environmentally friendly and conserves resources thanks to replaceable components

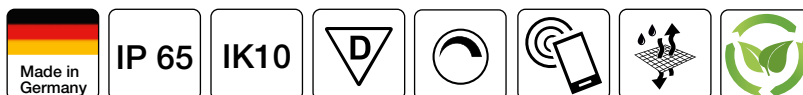



POSSIBLE APPLICATIONS

- + Building trade
- + Industry
- + Emergency and rescue services
(technical relief services, police, fire service,
Red Cross, etc.)
- + Event management

POWERDISK

Features



Luminaire tested for use with limited surface temperature according to DIN EN 60598-2-24



High degree of protection IP 65



Impact-resistant and break-proof housing

Glare-reduced light thanks to opal cover lens made of impact-resistant and non-yellowing polycarbonate

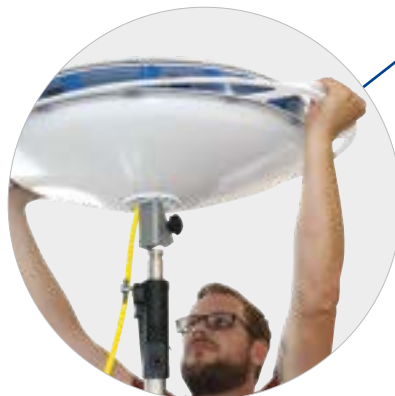

Quick one-person installation



DUSTPROOF

 as per
DIN EN 60598-1
DIN EN 60529

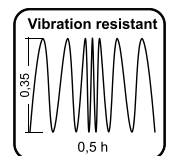

VIBRATION STABILITY

 as per
DIN EN 60598-1

How passive cooling works

In our passively cooled lighting fixtures, the heat inside the fixture is dissipated via an aluminium element, thus obviating the need for active cooling and rendering the lighting fixtures maintenance free.

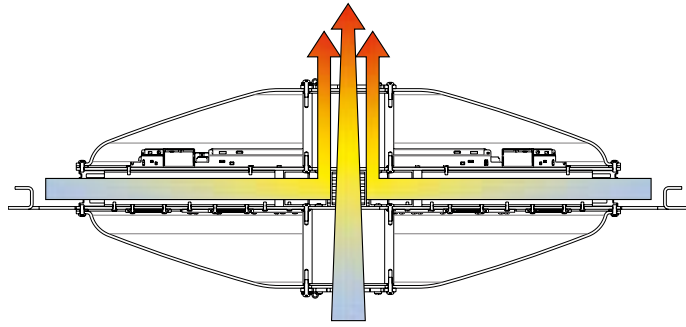

Environmentally friendly and conserves resources thanks to replaceable components

Versions with Casambi Bluetooth® control for wireless networking available



Integrated handle

Different connector systems and longer power supply cable on request

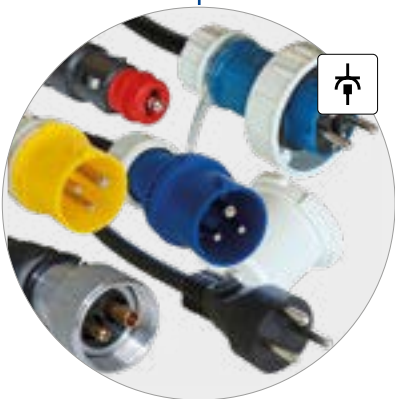

Dimmable version with push button switchable (I / 0, 1 ... 100%)

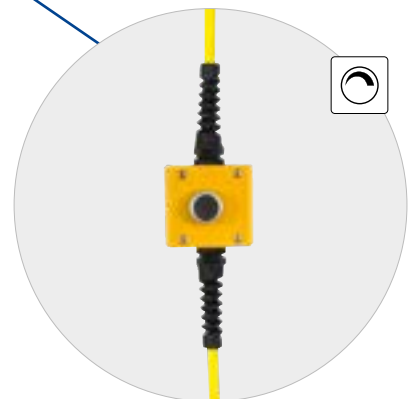



Housing aluminum / stainless steel, cover plastic (polycarbonate, opal), 10 m power supply cable with mains plug, incl. adapter for spigot 30 mm (DIN 14640).

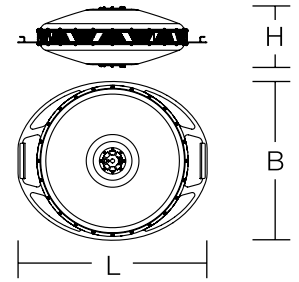

L 750, B 630, H 250 mm

Φ_V 52.000 lm effective

..... 5.000 K*, $R_a \geq 85$
..... 24 x COB-LED

..... 10 m, H07BQ-F
..... yellow

..... IK10

*3.000 K / 4.000 K - on request



P



230 V, 50-60 Hz

80P01000-0006	421 W	1 ... 100%	I	IP 65	E+F	15,7 kg
80P02000-0006	421 W	-	I	IP 65	E+F	14,8 kg
80P01001-0006	421 W	1 ... 100%	I	IP 65	E+F ⁶⁸	15,7 kg
80P02001-0006	421 W	-	I	IP 65	E+F ⁶⁸	14,8 kg
80P01006-0006	421 W	1 ... 100%	I	IP 65	CEE 6h	15,7 kg
80P02006-0006	421 W	-	I	IP 65	CEE 6h	14,8 kg
80P010CH-0006	421 W	1 ... 100%	I	IP 65	J	15,7 kg
80P020CH-0006	421 W	-	I	IP 65	J	14,8 kg

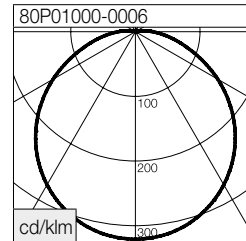

h (m)	Ø (m)	E (lx)
3	9,37	1852
5	15,62	667
10	31,24	167
20	62,47	42
30	93,71	19

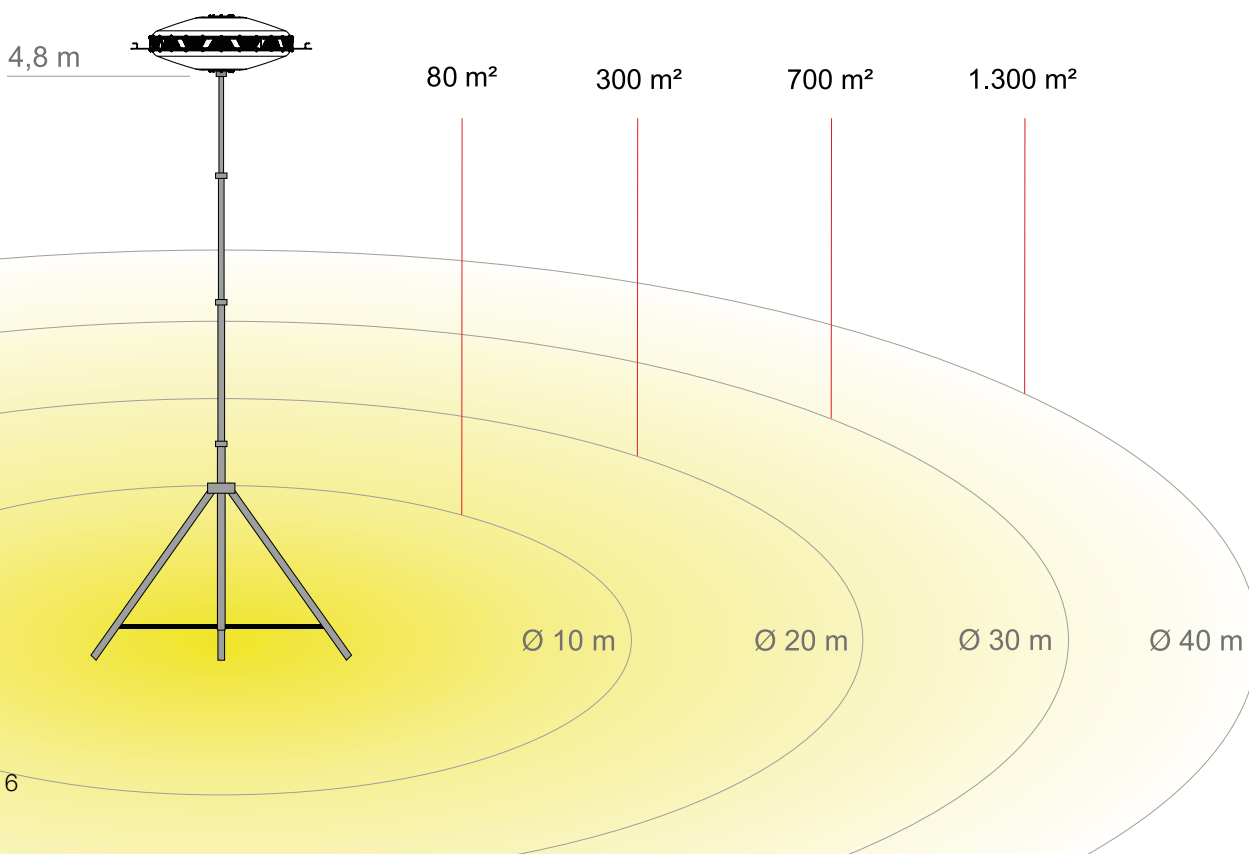

Housing aluminum / stainless steel, cover plastic (polycarbonate, opal), 10 m power supply cable with mains plug, incl. adapter for spigot 30 mm DIN 14640).

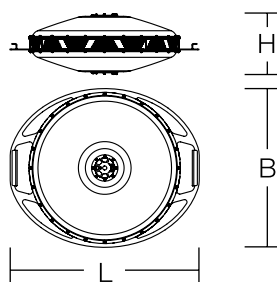

L 750, B 630, H 250 mm



230 V, 50-60 Hz

80P01000-0006.B	421 W	1 ... 100%	I	IP 65	E+F	15,6 kg
80P01001-0006.B	421 W	1 ... 100%	I	IP 65	E+F ⁶⁸	15,6 kg
80P01006-0006.B	421 W	1 ... 100%	I	IP 65	CEE 6h	15,6 kg
80P010CH-0006.B	421 W	1 ... 100%	I	IP 65	J	15,6 kg

Φ_v 52.000 lm effective

..... 5.000 K*, Ra ≥ 85
..... 24 x COB-LED

..... 10 m, H07BQ-F
..... yellow

..... IK10

*3.000 K / 4.000 K - on request

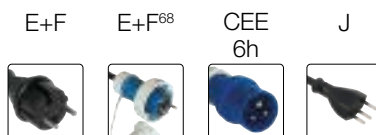
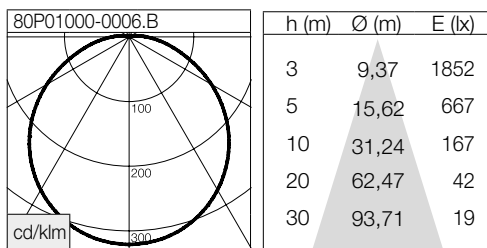

Smart Control

Smart Control stands for the intelligent remote control of our luminaires via mobile app from a mobile phone or tablet. It doesn't matter whether individual luminaires or groups of luminaires are to be controlled. All luminaires - even existing ones - can be controlled together with an integrated „Casambi“ module. Thus also our POWERTUBE II, POWERDISK and POWERCASE L. The luminaires are networked via Bluetooth from the mobile device to the luminaire and from luminaire to luminaire, which considerably increases the range of the luminaire network.

- ON/OFF
- Dimming
- Timer
- Scenes
- Animations



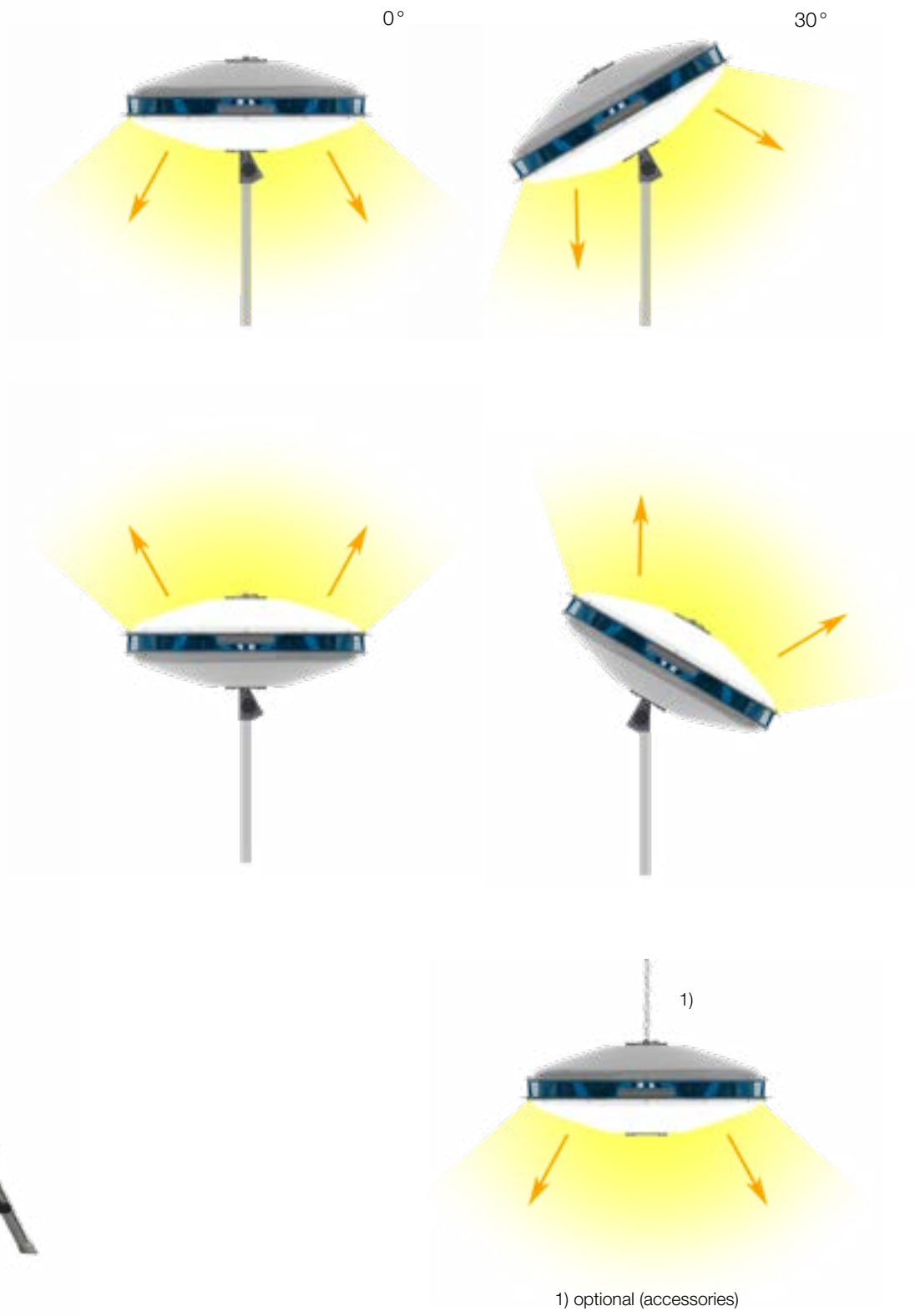



Accessories



Crank tripod "Premium"

Steel, chrome plated, suitable for 16 & 28 mm spigots, safety bolt, self braking clutch/winch, fold-away crank, one adjustable stand to compensate uneven terrain

incl. tripod adapter 28 mm/30 mm (DIN 14640)

Packed dimensions:
L 1.850, B 230, H 160 mm

95-0060-0014.D H max 3800, H min 1740, D 1300 mm 22,5 kg



Crank tripod „LightmaXX“

Galvanised steel, chrome-plated and powder-coated, with spigot adapter, automatic safety lock, 1 foot adjustable for levelling on uneven ground, self-braking coupling, fold-away elevator

incl. tripod adapter 28 mm/30 mm (DIN 14640)

incl. clamping kit for tripod

Pack dimensions:
L 1.810, B 300, H 250 mm

95-0294-0014 H max 4130, H min 1750, D 1730 mm 25,0 kg



Hinged feet with rubber pad

For crank tripod "Premium", stainless steel, Set (3 pieces)



95-0266-0001 0,43 kg



Bracing set

3 x rope cord and peg

95-0267-0001 1,1 kg

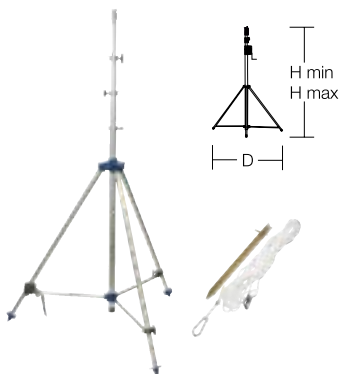

Tripod "Professionell"

Stainless steel, air-cushioned for safe and comfortable operation, adjustable stand to compensate uneven terrain, with standard spigot 30 mm (DIN 14640), including bracing set (3 x rope cord and peg)



Packed dimensions:
L 1.120, B 200, H 200 mm

95-0257-0014 H max 4450, H min 1100, D 1600 mm 13,3 kg

Carrier box for Tripod "Premium"

Wood, 2 carrier handles
(set with tripod: right side)





 95-0265-0040	 L 1990, B 325, H 225 mm	 21,2 kg
---	---	---

Carrier box for Tripod "Professionell"

Wood, 3 carrier handles





 95-0258-0040	 L 1210, B 265, H 225 mm	 11,9 kg
---	---	---

Carrier bag for Tripod "Professionell"



Black, 2 carrier handles and shoulder belt



 95-0264-0001	 L 1150, B 130, H 240 mm	 0,6 kg
---	---	--

Set Tripod "Professionell"



The set includes:
Tripod "Professionell",
carrier box

 95-0257-0014S1	 L 1210, B 265, H 225 mm	 25,1 kg
---	---	---



Set Crank tripod "Premium"

The set includes:
Crank tripod "Premium", tripod adapter,
bracing set, carrier box

 95-0060-0014S1	L 1990, B 325, H 225 mm	 44,0 kg
---	-------------------------	---



Accessories





**Tripod adapter
28 mm/30 mm (DIN 14640)**

Stainless steel, for connection to existing stands with 28 mm

 95-0254-0014	 L 108, D 38 mm	 0,5 kg
--	--	--





Adapter for suspended mounting

Ø 17 mm

 95-0255-0014	 L 70, B 65, H 72 mm	 0,12 kg
--	---	---





**Carrier bag
for "POWERDISK"**

Handles, shoulder belt and transport rollers

 95-0259-0001	 L 850, B 240, H 680 mm	 6,6 kg
--	--	--

**Carrier box
for "POWERDISK"**

Wood, 2 carrier handles

 95-0256-0040	 L 740, B 290, H 805 mm	 17 kg
--	--	---

**Set
„POWERDISK“**

The set includes:
“POWERDISK”,
adapter for suspended mounting,
carrier bag



	P				
230 V, 50-60 Hz					
80P01000-0006S2	421 W	✓	I	IP 65	E+F
80P02000-0006S2	421 W	-	I	IP 65	E+F
80P01001-0006S2	421 W	✓	I	IP 65	E+F ⁶⁸
80P02001-0006S2	421 W	-	I	IP 65	E+F ⁶⁸
80P01006-0006S2	421 W	✓	I	IP 65	CEE 6h
80P02006-0006S2	421 W	-	I	IP 65	CEE 6h
80P010CH-0006S2	421 W	✓	I	IP 65	J
80P020CH-0006S2	421 W	-	I	IP 65	J

**Set
„POWERDISK“**

The set includes:
“POWERDISK”,
adapter for suspended mounting,
carrier box



	P				
230 V, 50-60 Hz					
80P01000-0006S1	421 W	✓	I	IP 65	E+F
80P02000-0006S1	421 W	-	I	IP 65	E+F
80P01001-0006S1	421 W	✓	I	IP 65	E+F ⁶⁸
80P02001-0006S1	421 W	-	I	IP 65	E+F ⁶⁸
80P01006-0006S1	421 W	✓	I	IP 65	CEE 6h
80P02006-0006S1	421 W	-	I	IP 65	CEE 6h
80P010CH-0006S1	421 W	✓	I	IP 65	J
80P020CH-0006S1	421 W	-	I	IP 65	J



Mobiles Licht für Profis – Made in Germany

Portable light for professionals – Made in Germany

*Éclairage mobile pour les professionnels –
Fabriqué en Allemagne*

SONLUX Lighting GmbH

Frankenhäuser Straße 66
99706 Sondershausen
Germany

Phone +49 3632 6522 - 0
Fax +49 3632 6522 - 822

www.sonlux.de
info@sonlux.de



Tip with added value:

The digital version of this publication contains **interactive links** that lead you from the article number directly to the web.



Member of

licht.de